

SISTEMA DE MONTAJE DE 1 COLUMNA DE 2 PANELES
HORIZONTALES INCLINADO A 20°

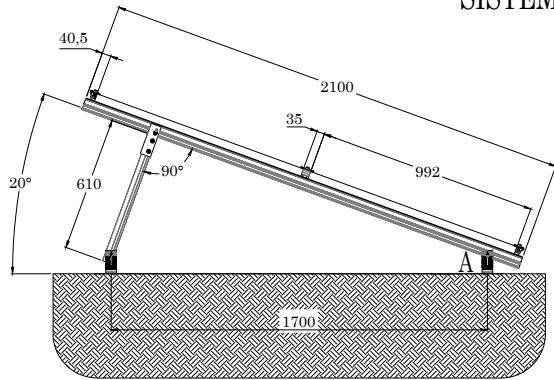

VISTA LATERAL

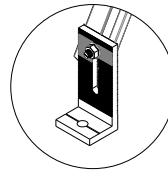

DETALLE A
Soporte "L"

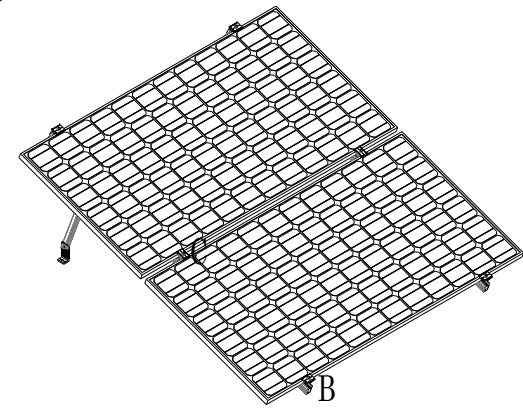

VISTA ISOMÉTRICA

72 Celdas

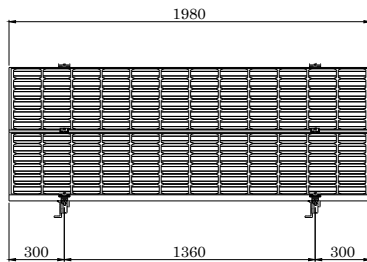

60 Celdas

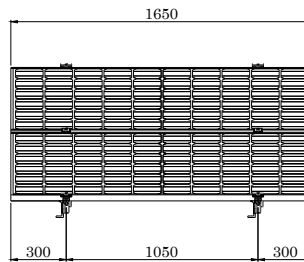

VISTA FRONTAL

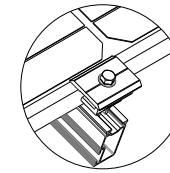

DETALLE B
Abrazadera Universal
(Modo Remate)

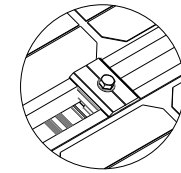

DETALLE C
Abrazadera Universal
(Modo Intermedio)

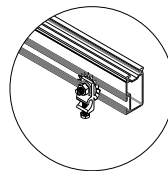

Terminal de
Conexión a Tierra

# Parte	Descripción	Cantidad
NXT-R-2100-MILL	Perfil NextRail 2.1m, mill finish, Aluminio 6105-T6	2
NXT-AU-2	2 Abrazadera universal p/panel con marco de 30-50mm	3
NXT-AR-1500	Ángulo-Riel 1.5m, mill finish, Alu 6105-T6	1
NXT-SL-2	2 Soporte L de 105mm para Next-Rail	2
NXT-CAR-1	1 Conector de ángulo riel para Next-Rail	2
NXT-TCT-1	1 Terminal de conexión a tierra para Next-Rail	1
NXT-PCT-4	4 Placas de conexión final a tierra (panel-riel)	1
NXT-CP-5	5 Clips de Plástico para 2 cables, Next-Rail	1

observaciones:		 Aluminio que transforma	
MATERIAL:		N° DE DIBUJO	A3
FECHA	01/09/2020	NXT-SM-2H-20	
ACOT.	mm [in]	ESCALA: NA	H041 DE 1
PESO:	6.46 kg		