

# SISTEMA DE MONTAJE DE 2 PANELES INCLINADO 10 - 15° 72 CELDAS

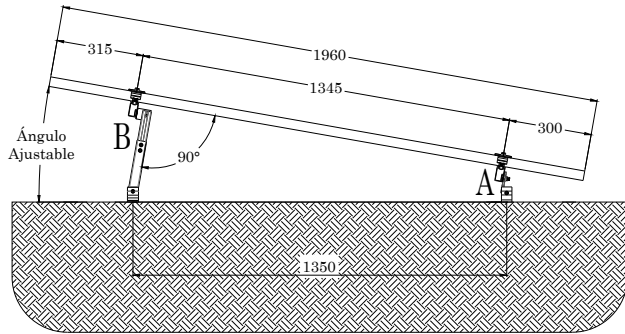

VISTA LATERAL

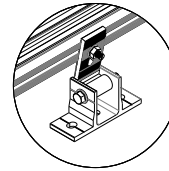

DETALLE A  
Soporte Frontal Ajustable

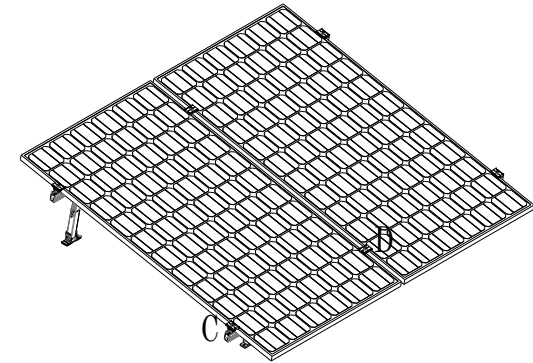

VISTA ISOMÉTRICA

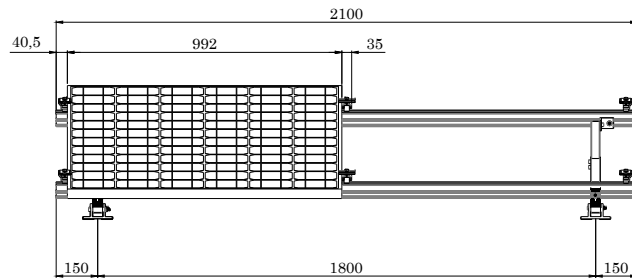

VISTA FRONTAL

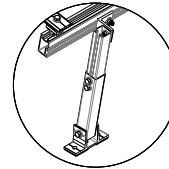

DETALLE B  
Soporte Trasero Ajustable

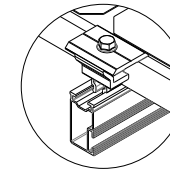

DETALLE C  
Abrazadera Universal  
(Modo Remate)

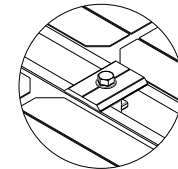

DETALLE D  
Abrazadera Universal  
(Modo Intermedio)

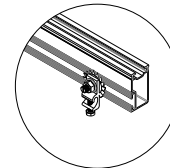

Terminal de  
Conexión a Tierra

# Parte	Descripción	Cantidad
NXT-R-2100-MILL	Perfil NextRail 2.1m, mill finish, Aluminio 6105-T6	2
NXT-R-4300-MILL	Perfil NextRail 4.3m, mill finish, Aluminio 6105-T6	0
NXT-ER-2	2 Empalmes de riel con puesta a tierra, para Next-Rail	0
NXT-AU-2	2 Abrazadera universal p/panel con marco de 30-50mm	3
NXT-TCT-1	1 Terminal de conexión a tierra para Next-Rail	1
NXT-PCT-4	4 Placas de conexión final a tierra (panel-riel)	1
NXT-CP-5	5 Clips de Plástico para 2 cables, Next-Rail	1
NXT-SFA-1	1 Soporte frontal ajustable para Next-Rail	2
NXT-STA-10/15-1	1 Soporte trasero ajustable 10-15° para Next-Rail	2

observaciones:		 Aluminio que transforma	
MATERIAL:		N° DE DIBUJO	A3
FECHA	01/09/2020	NXT-SMI-2-15-72	
ACOT.	mm [in]	ESCALA NA	HOJA 1 DE 1
PESO:	5,56 kg		